

Product Summary

$V_{(BR)DSS}$	$R_{DS(on)TYP}$	I_D
30V	4.0m Ω @10V	90A
	6.3m Ω @4.5V	

Feature

- Trench Technology Power MOSFET
- Low $R_{DS(ON)}$
- Low Gate Charge
- Low Gate Resistance
- 100% UIS Tested

Application

- Power Management
- Load Switching
- Motor Driving
- High frequency switching, synchronous rectification

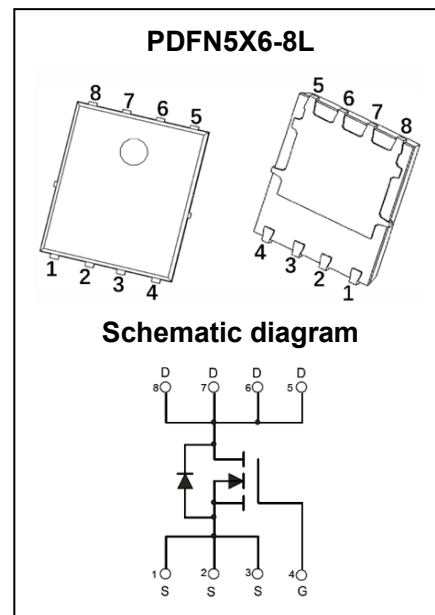

Package Marking and Ordering Information

Part Number	Package	Marking	Packing	Reel Size	Tape Width	Qty
GPM042N03LNC	PDFN5X6-8L	M042N03L	Reel & Tape	330mm	12mm	5000pcs

ABSOLUTE MAXIMUM RATINGS ($T_A = 25^\circ\text{C}$ unless otherwise noted)

Parameter	Symbol	Value	Unit
Drain-Source Voltage	V_{DS}	30	V
Gate-Source Voltage	V_{GS}	± 20	V
Continuous Drain Current ¹	I_D	$T_C = 25^\circ\text{C}$	90
		$T_C = 100^\circ\text{C}$	57
Pulsed Drain Current ²	I_{DM}	360	A
Single Pulsed Avalanche Current ³	I_{AS}	19	A
Single Pulsed Avalanche Energy ³	E_{AS}	90	mJ
Power Dissipation ⁵	P_D	83	W
Thermal Resistance from Junction to Ambient ⁶	$R_{\theta JA}$	38	$^\circ\text{C/W}$
Thermal Resistance from Junction to Case	$R_{\theta JC}$	1.5	$^\circ\text{C/W}$
Junction Temperature	T_J	-55~ +150	$^\circ\text{C}$
Storage Temperature	T_{STG}	-55~ +150	$^\circ\text{C}$

MOSFET ELECTRICAL CHARACTERISTICS ($T_A = 25^\circ\text{C}$ unless otherwise noted)

Parameter	Symbol	Test Condition	Min	Type	Max	Unit
Off Characteristics						
Drain-Source Breakdown Voltage	$V_{(BR)DSS}$	$V_{GS} = 0V, I_D = 250\mu A$	30			V
Zero Gate Voltage Drain Current	I_{DSS}	$V_{DS} = 30V, V_{GS} = 0V$			1	μA
Gate-Body Leakage Current	I_{GSS}	$V_{GS} = \pm 20V, V_{DS} = 0V$			± 100	nA
On Characteristics⁴						
Gate Threshold Voltage	$V_{GS(th)}$	$V_{DS} = V_{GS}, I_D = 250\mu A$	1.0	1.5	2.0	V
Drain-Source On-Resistance	$R_{DS(on)}$	$V_{GS} = 10V, I_D = 20A$		4.0	5.2	$m\Omega$
		$V_{GS} = 4.5V, I_D = 15A$		6.3	9.0	$m\Omega$
Forward Transconductance	g_{FS}	$V_{DS} = 5V, I_D = 20A$	30			S
Dynamic Characteristics						
Input Capacitance	C_{iss}	$V_{DS} = 15V, V_{GS} = 0V, f = 1MHz$		1539		pF
Output Capacitance	C_{oss}			169		
Reverse Transfer Capacitance	C_{rss}			165		
Gate Resistance	R_g	$V_{DS} = 0V, V_{GS} = 0V, f = 1MHz$		5.0		Ω
Switching Characteristics						
Total Gate Charge	Q_g	$V_{DS} = 15V, V_{GS} = 10V, I_D = 20A$		40		nC
Gate-Source Charge	Q_{gs}			3.8		
Gate-Drain Charge	Q_{gd}			12.8		
Gate Plateau Voltage	$V_{plateau}$			3.0		V
Turn-On Delay Time	$t_{d(on)}$	$V_{DD} = 15V, V_{GS} = 10V, I_D = 20A,$ $R_G = 3\Omega$		2.5		ns
Turn-On Rise Time	t_r			14		
Turn-Off Delay Time	$t_{d(off)}$			25		
Turn-Off Fall Time	t_f			15		
Source-Drain Diode Characteristics						
Diode Forward Voltage ⁴	V_{SD}	$V_{GS} = 0V, I_S = 20A$			1.2	V
Diode Continuous Forward Current ¹	I_S	$T_C = 25^\circ\text{C}$			90	A
Diode Pulse Forward Current ²	I_{SM}	$T_C = 25^\circ\text{C}$			360	A
Diode Reverse Recovery Time	t_{rr}	$I_F = 20A, dI/dt = 100A/\mu s$		12		ns
Diode Reverse Recovery Charge	Q_{rr}	$I_F = 20A, dI/dt = 100A/\mu s$		4.5		nC

Notes:

- The maximum current rating is limited by package. And device mounted on a large heatsink.
- Pulse Test: Pulse Width $\leq 10\mu s$, duty cycle $\leq 1\%$.
- E_{AS} condition: $V_{DD} = 15V, V_{GS} = 10V, L = 0.5mH, R_G = 25\Omega$ Starting $T_J = 25^\circ\text{C}$.
- Pulse Test: Pulse Width $\leq 300\mu s$, duty cycle $\leq 2\%$.
- The power dissipation P_D is limited by $T_{J(MAX)} = 150^\circ\text{C}$. And device mounted on a large heatsink.
- Device mounted on $1in^2$ FR-4 board with 2oz. Copper, in a still air environment with $T_A = 25^\circ\text{C}$.

Typical Characteristics

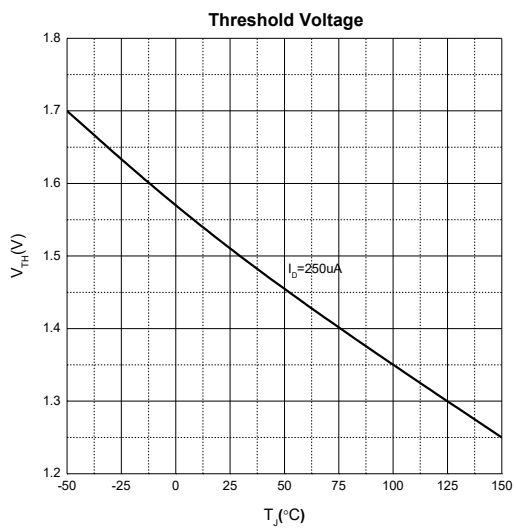
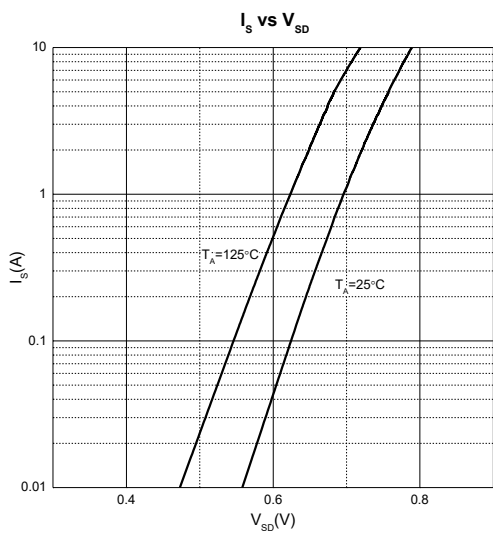
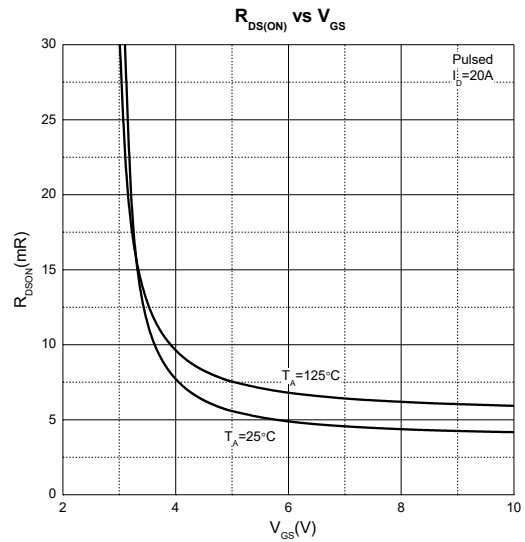
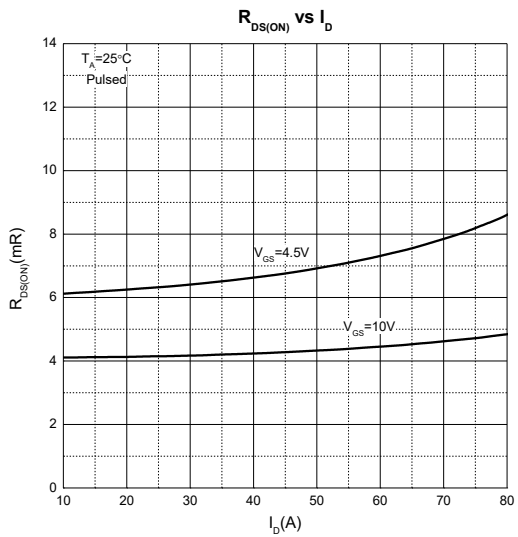
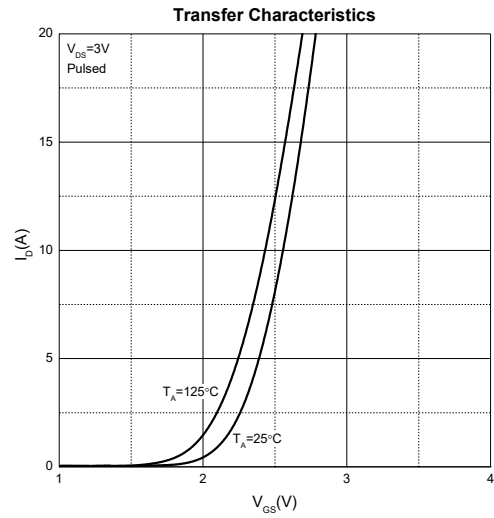
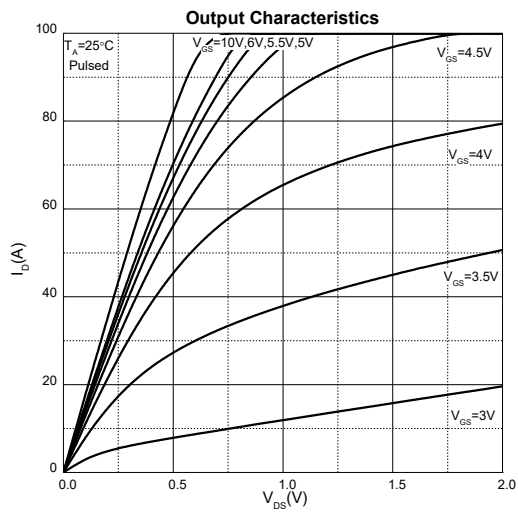

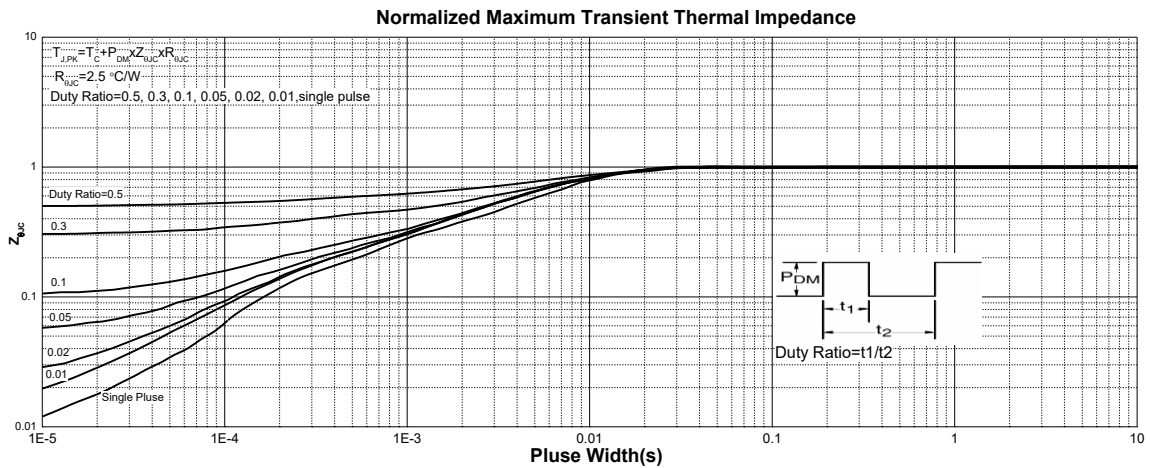
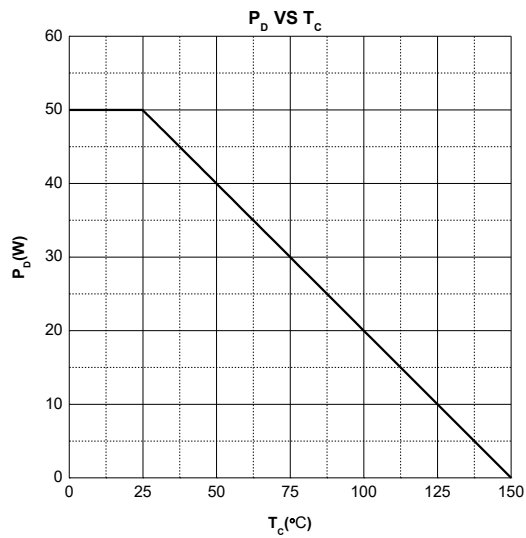
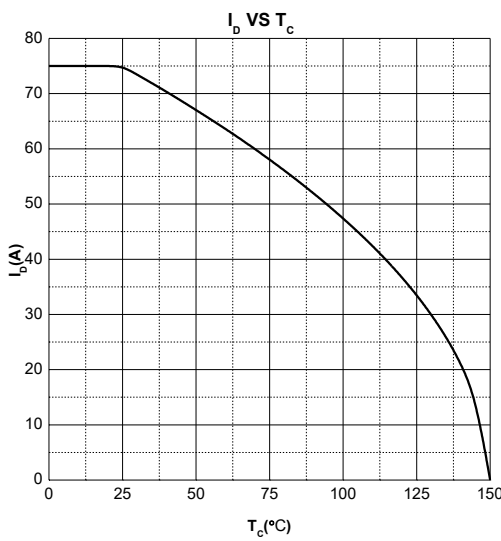
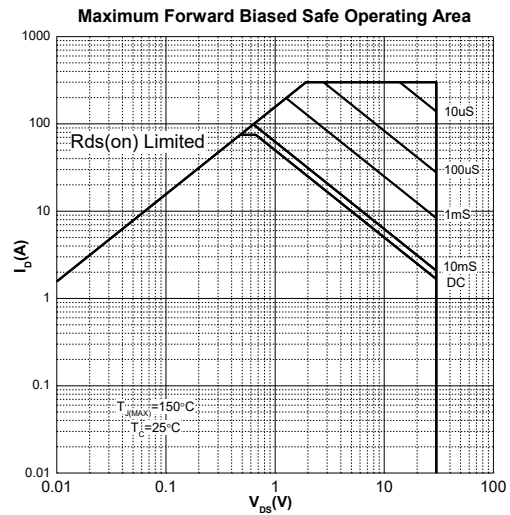
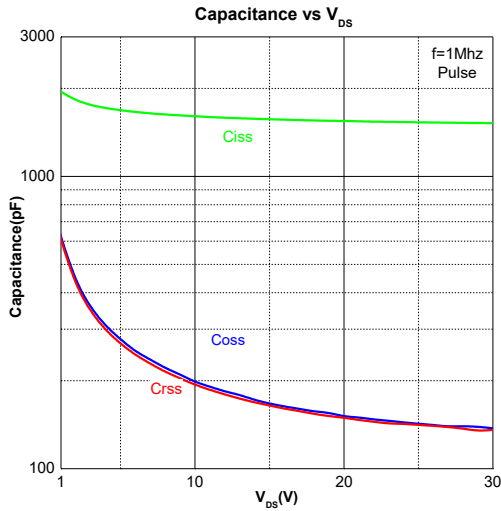

Test Circuit

Gate Charge Test Circuit & Waveform

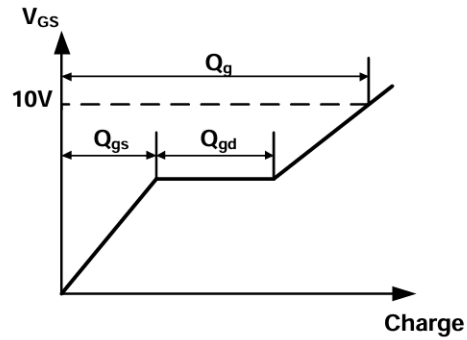
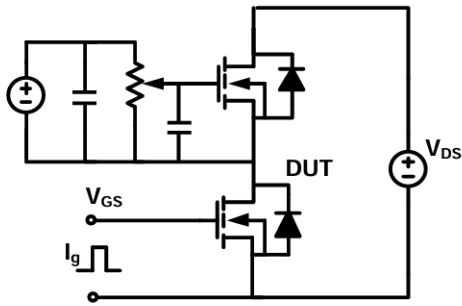

Resistive Switching Test Circuit & Waveform

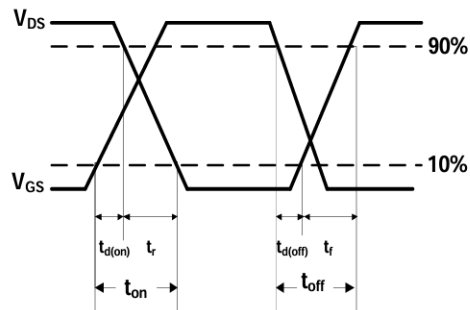
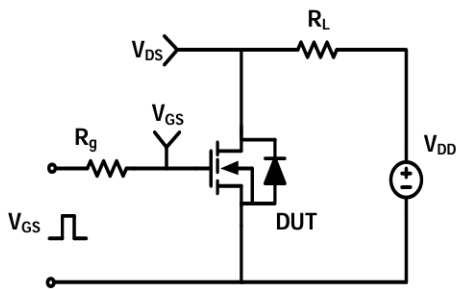

Unclamped Inductive Switching (UIS) Test Circuit & Waveform

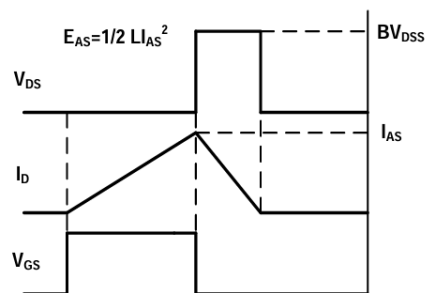
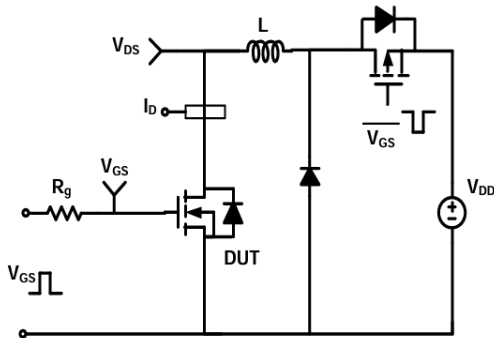

Diode Recovery Test Circuit & Waveform

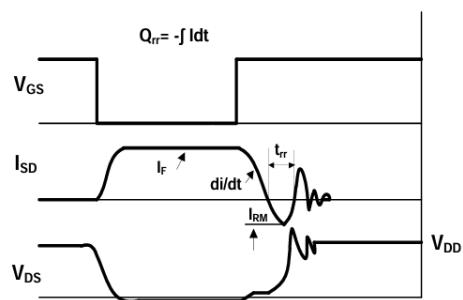
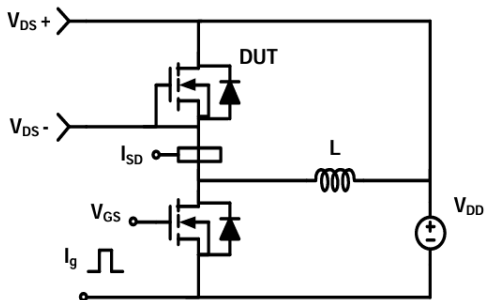

PDFN5X6-8L Package Information

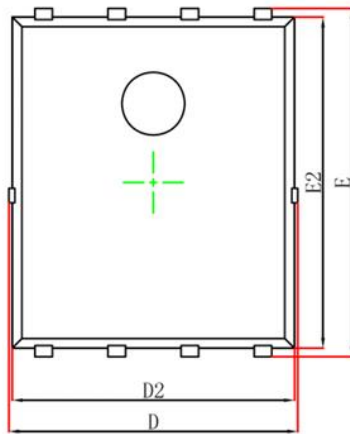

Top View
[顶视图]

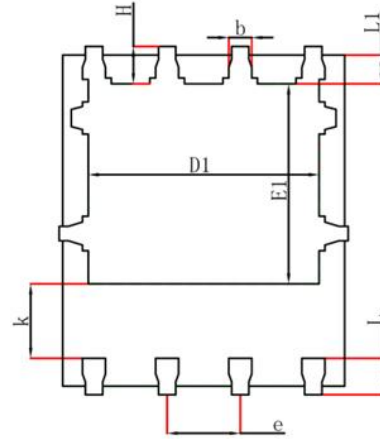

Bottom View
[背视图]

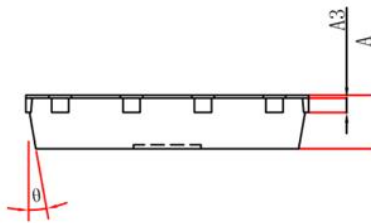

Side View
[侧视图]

Symbol	Dimensions In Millimeters		Dimensions In Inches	
	Min.	Max.	Min.	Max.
A	0.900	1.10	0.035	0.043
A3	0.254REF		0.010REF	
D	4.700	5.260	0.185	0.207
E	5.750	6.250	0.226	0.246
D1	3.560	4.500	0.140	0.177
E1	3.180	3.660	0.125	0.144
D2	4.700	5.100	0.185	0.201
E2	5.600	6.000	0.220	0.236
k	1.100	-	0.043	-
b	0.300	0.500	0.012	0.020
e	1.270TYP		0.050TYP	
L	0.510	0.710	0.020	0.028
L1	0.424	0.576	0.017	0.023
H	0.510	0.710	0.020	0.028
θ	8°	12°	8°	12°

Attention:

- GreenPower Electronics reserves the right to improve product design function and reliability without notice.
- Any and all semiconductor products have certain probability to fail or malfunction, which may result in personal injury, death or property damage. Customer are solely responsible for providing adequate safe measures when design their systems.
- GreenPower Electronics products belong to consumer electronics or other civilian electronic products.